



Equipment Guide

BE C

NEW · USED · RENTALS · PARTS · SERVICE

Rely On Brown

Keeping you on the job.

Our goal is simple. Keep our customers on the job. Locally owned, Brown Equipment Company is a consumer-driven dealership that focuses on providing the right solutions and unparalleled service to our customers. We partner with innovative manufacturers to deliver a robust, comprehensive selection of products to meet a variety of customer needs. From heavy equipment to traffic safety signs, to remote-operated mowers, to wireless communication, BEC is honored and proud to be a knowledgeable resource for product sales and support always striving for the best customer experience.

New, Used, Rentals, Parts & Service





















- Sewer Equipment
- Street and Highway Equipment
- Highway Safety and Traffic Control
- Air and Hydro Excavators
- Manhole and Safety Equipment
- Multi-use Tractors
- Locators
- Diagnostics & Drain Cleaning
- Camera Inspection Systems

BrownEquipment.net
(800) 747-2312

Serving Indiana, Kentucky, Ohio, and Michigan.

	IN	KY	OH	MI
	✓	✓	✓	
	✓	✓		
BUCHER municipal	✓	✓		
	✓	✓	✓	✓
	✓	✓		
Sonetics	✓	✓	✓	✓
	✓			
ARM TRUCKCORP	✓	✓	✓	✓
WANCO	✓	✓	✓	✓
	✓	✓	✓	✓
KEG	✓	✓	✓	
RC-MOWERS	✓	✓		
	✓	✓	✓	✓
	✓	✓	✓	✓
RADIODETECTION	✓	✓	✓	✓
SCHONSTEDT	✓	✓	✓	✓

Table of Contents

	Street Sweepers	4
	Street Sweepers	6
	Seasonal & Road Maintenance	8
	Remote Control Slope Mowers	10
	Traffic Safety Signs	11
	Multi-purpose Tractors	12
	Diagnostics & Drain Cleaning	14
	Camera Inspection Systems	16
 	Locators	18
	Valve Maintenance Systems	19
 	Jetters & Easement Machines	20
	Combination Sewer Cleaners	22
 	Vacuum Excavators	26
	Specialty Sewer Machines	28
	Sewer Cleaning Nozzles	30
	Vanguard System	31
 	Manhole & Safety Equipment	32
	Rental Equipment	34
	Camera Services	36
	Full-Maintenance Service & Repairs	38
	Reconditioning	40
	Custom Builds & Fabrication	42
	Parts & Accessories	43

Street Sweepers



Global® Street Sweepers

Purpose built, heavy duty and simply tough street sweepers.

Models	
<p>M3</p> <p>Sweeping speed up to 9mph Travel speed up to 24mph 130HP Cummins engine</p>	<p>M4</p> <p>Sweeping speed up to 11mph Travel speed up to 67mph 280HP Cummins engine</p>

Turning Radius

M3 | R3



M4 | M4HSD | R4



9' 6\"/>



Optional 100% stainless steel hopper with lifetime warranty





**Only
Class 7 100%
electric street
sweeper in
the USA**

M4 Electric | 9-11 hours operational time



M3 Electric | 9-11 hours operational time

Global® M3EV & M4EV Street Sweepers

- Zero CO₂ Emissions to reduce global pollution
- Up to 10-year battery life
- 9-11 hours operational time

Models
<p>Global M3CNG Sweeping speed up to 9mph</p>
<p>Global M4CNG Sweeping speed up to 9mph</p>
<p>Global M4 Hybrid Travel speed up to 60mph Over 50% increase in fuel economy</p>
<p>Global M3 Electric Sweeper Sweeping speed up to 11mph Travel speed up to 25mph</p>
<p>Global M4 Electric Sweeper Sweeping speed up to 11mph Travel speed up to 60mph</p>

MADE IN THE USA 

Street Sweepers

BUCHER
municipal

Bucher Municipal V65 Range Truck Mounted Sweepers

All-inclusive warranty (2 years/2,000 hours)

- 8.5 yd³ hopper capacity
- 410 gal water tank
- Complete hopper constructed of 9 ga stainless steel: 250-times better corrosion resistance than standard or even 304 stainless steel
- Low Environmental Impact: Reduces water usage by 20% with ability to save up to 237 gal of water per day
- Available with a single engine, twin engine, or hydrostatic engine.

Lifetime warranty on entire hopper body





CityCat 5006

Bucher Municipal CityCat Compact Street Sweeper

- Water capacity 232 gal
- Hydrostatic-controlled four-wheel steering
- Up to 31 mph traveling speed
- 7.3 yd³ hopper volume
- Stainless steel hopper construction



9' 8"
turning
radius

Seasonal & Road Maintenance



Leaf Collectors

- 1 person operation
- 17, 25, or 30 yd³ hopper availability
- 6 way hydraulic hose boom controlled by an in-cab joystick



ALC 25 Leaf Collector



Truck Mounted Leaf Collector

Snow and Ice Management

Complete line of heavy duty snowplow systems and integrated custom upfit solutions can service city streets, rural roads and interstate highways.



Snow Plow



Snow Plow



Dump Body / Ice Spreader



Spaulding Hot Patchers

Optional fully oil jacketed hopper



Heavy duty steel construction



Fully insulated



Even thermal heat



Gravity fed design



Spring loaded top doors



Options



Remote Control Slope Mowers



- Low center of gravity and wide base allow for safely mowing slopes up to 50°
- Extremely low ground pressure ideal for soft, wet terrain
- Remote-control connectivity up to a range of 1,000 ft
- No special operator certification
- 20-hour run time
- 30-day money back guarantee
- 72-hour parts shipping guarantee

MADE IN  THE USA

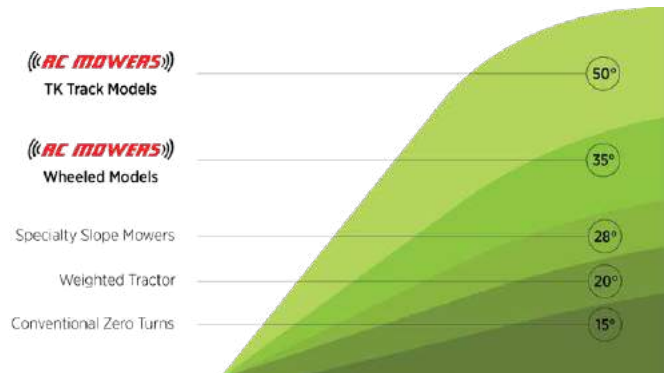

Each RC Mower includes a commercial grade remote allowing safe operation up to 1,000 ft away.

Traffic Safety Signs



Variable Message Boards

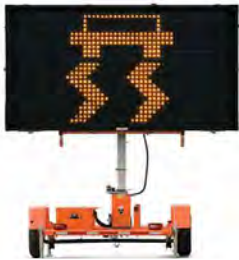

Full-Size Matrix
WTMMB



Mini Matrix
WVTM



Metro Matrix
WVTMM



Full-Size Remote-Video
Monitoring System
WTMMBC



Mini Remote-Video
Monitoring System
WVTMC



Full-Size Three-Line
WTLMB



Mini Three-Line
WVT3



5-Color Matrix
WVTM-5c



International Matrix
WEMB



Truck-Mount Matrix
WMB-V

Arrow Board Trailers



Vertical Trailer



Folder Trailer

Modems

The Wanco Modem Package with GPS provides remote access and control to Wanco Message Signs using an Internet-connected computer, tablet or smartphone. Remote access saves time, improves safety and provides up-to-date information.



Light Tower



Diesel, Vertical Tower
WLTV



Diesel, Laydown Tower
WLT

Additional Options

- Arrow board skirts
- Truck mount arrow boards
- Balloon light
- Solar light towers
- Portable camera trailers
- Radar-speed signs
- Fold-n-go portable sign trailers
- X-markers

Multi-purpose Tractors

- 360° unrestricted cabin view
- First class comfort with full independent spring and damper suspension
- Incredibly simple operation
- Quick and easy change of attachments



CX 75HP



MXC LP 130HP



MXC 130HP



MX 130HP





CV
Sweeper



Diagnostics & Drain Cleaning

The Most Innovative System in the Industry.

When problems are lurking in-pipe, behind walls or anywhere underground, more professionals choose RIDGID drain cleaning, diagnostics, locating and thermal imaging tools than any other brand. That's because RIDGID sets the industry standard for ease of use, durability and advanced functionality. Every tool is purpose-built based on feedback from professionals in the field and backed by one of the best warranties in the industry. Build your business with the most complete system of professional inspection, diagnostic, thermal imaging and drain cleaning tools available. See it. Find it. Solve it.



RIDGID® GIVES YOU THE **COMPETITIVE EDGE.**

RIDGID



Camera Inspection Systems

CUES

- Unmatched loaner inventory for life of the equipment
- Service centers throughout the USA, including BEC's state-of-the-art facility in Indiana



CCTV Truck



CCTV Transit Van



CCTV Transit Van



C550c Hunter Base Station



"The Standard of the Industry"



Micro Pan & Tilt

Features

- White LED lighting
- Built-in lens wiper
- Detachable steering wand
- Self-leveling camera head
- Built-in sonde

Manhole Inspection Systems



SPiDER



SPiDER



QZ III

Portable Systems



MADE IN THE USA 

Locators

RADIODETECTION®



Local Support



Logistics



Training



Service



RD7200

Cable, Pipe and RF Marker Locator



RD8200

Cable, Pipe and RF Marker Locator



RD8200

SCHONSTEDT®

Magnetic Metal Locators



Valve Maintenance Systems



- Curbside operation and control with optional wireless remote control
- System driven hydraulic, vacuum and pressurized water
- Vacuum with power operated debris tank
- Choice of ERV-750 or TM-7 valve exercisers
- Data storage and collection via VITALS software
- Class 2 hydraulics drive



Jetters & Easement Machines



747 Trailer Jetter

- One piece enclosure
- Duraprolene water tank
- Box tube frame
- NEMA 4 wiring



Easement Machines

- Rotating hose reel
- Aluminum constructions
- Automatic level wind
- Track drive system approach



Mongoose Jetter



800 Truck Jetter

- Climate controlled environmental enclosure with 80,000 BTU heater
- ECO operating platform
- Rotating hose reel
- Small footprint
- Single and dual reel configuration
- Optional CUES camera jet pod system with TV monitor
- Rear door closure after extending the jet reel for maximum heat retention (Series IV)

Water Tanks

Duraprolene tanks with fully-baffled interior

$\frac{3}{4}$ " Duraprolene water tanks

Rated 180 to -40 degrees for windchill

Water capacities from 1000 to 4500 gallons



Combination Sewer Cleaners

Sewer Equipment of America - 900 ECO



9 yard
single
axle



Top Features



**NO CHASSIS
INTEGRATION**



**SIMPLE
OPERATOR
INTERFACE**



**HYDRO DRIVE
POWERTRAIN
SYSTEM**



**SIMPLE
START UP**



**DURAPROLENE
WATER TANKS**

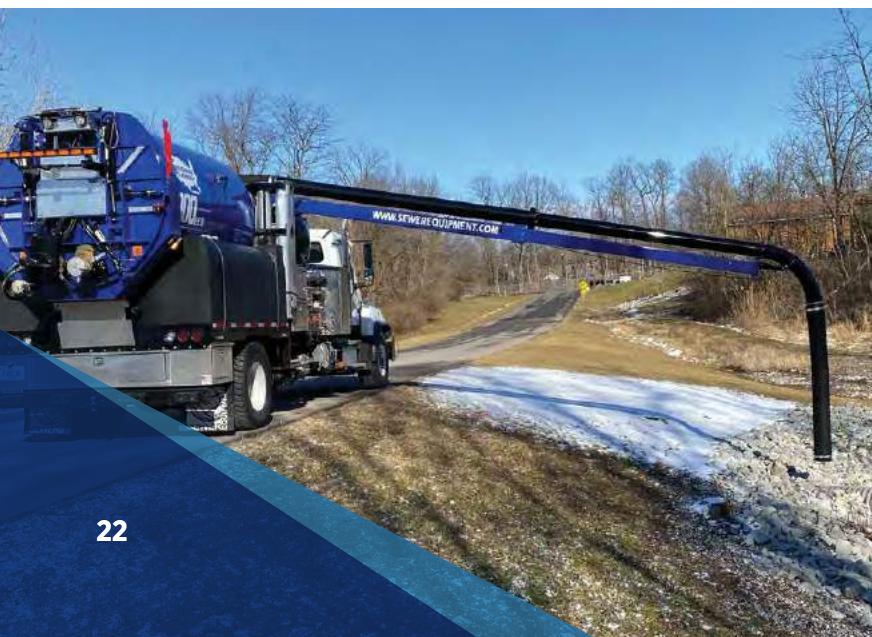



- Only single engine PD combo truck that runs in neutral
- Patented Hydro Drive system
- Standard Vac-on-the-Go
- 12-volt architecture with no computers or CAN Bus system
- Dig deep boom
- 3-stage air filtration system with dual 10-micron air filters
- 4" pump off system at 800 gpm with ability to pass up to a 3" solid

Water Tanks
½" Duraprolene water tanks
Rated 180 to -40 degrees for windchill



Single piston pump



Triplex pump



900 ECO Configurations

6 YARD 900 ECO WITHOUT BEHIND CAB TOOL BOX, TRIPLEX PUMP

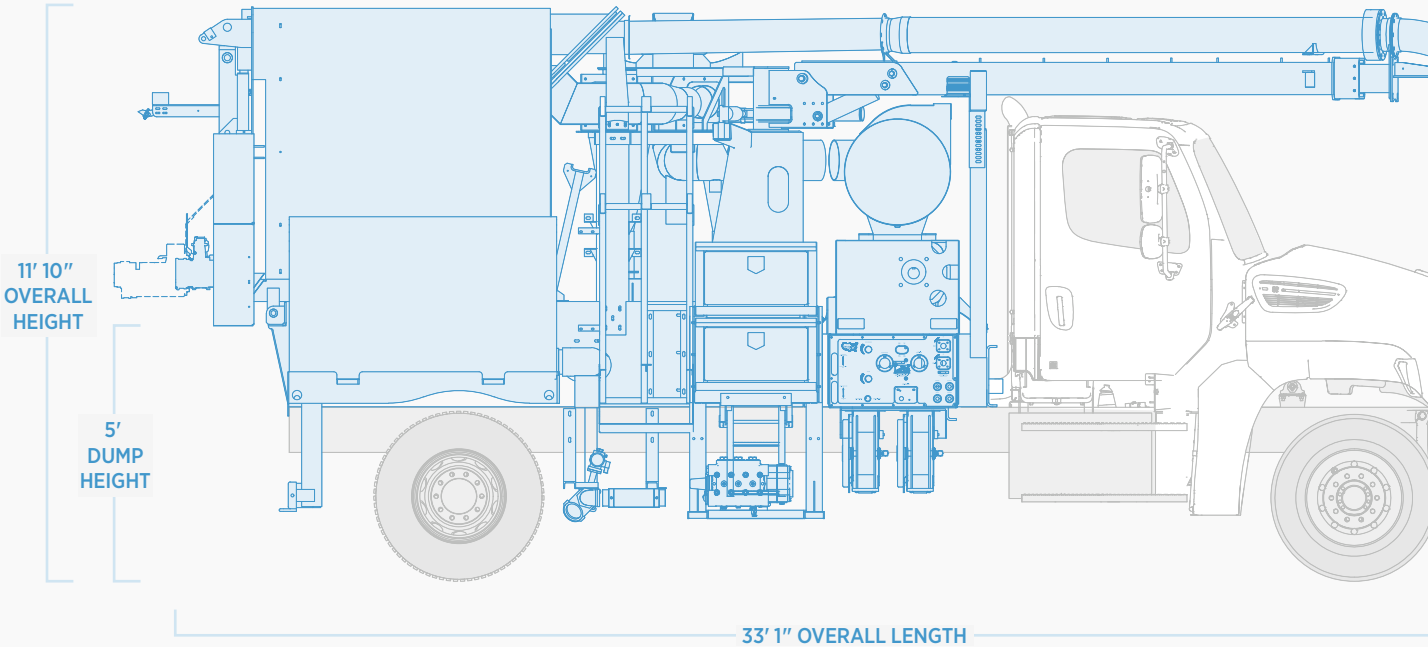

9 YARD 900 ECO WITHOUT BEHIND CAB TOOL BOX, SINGLE PISTON PUMP

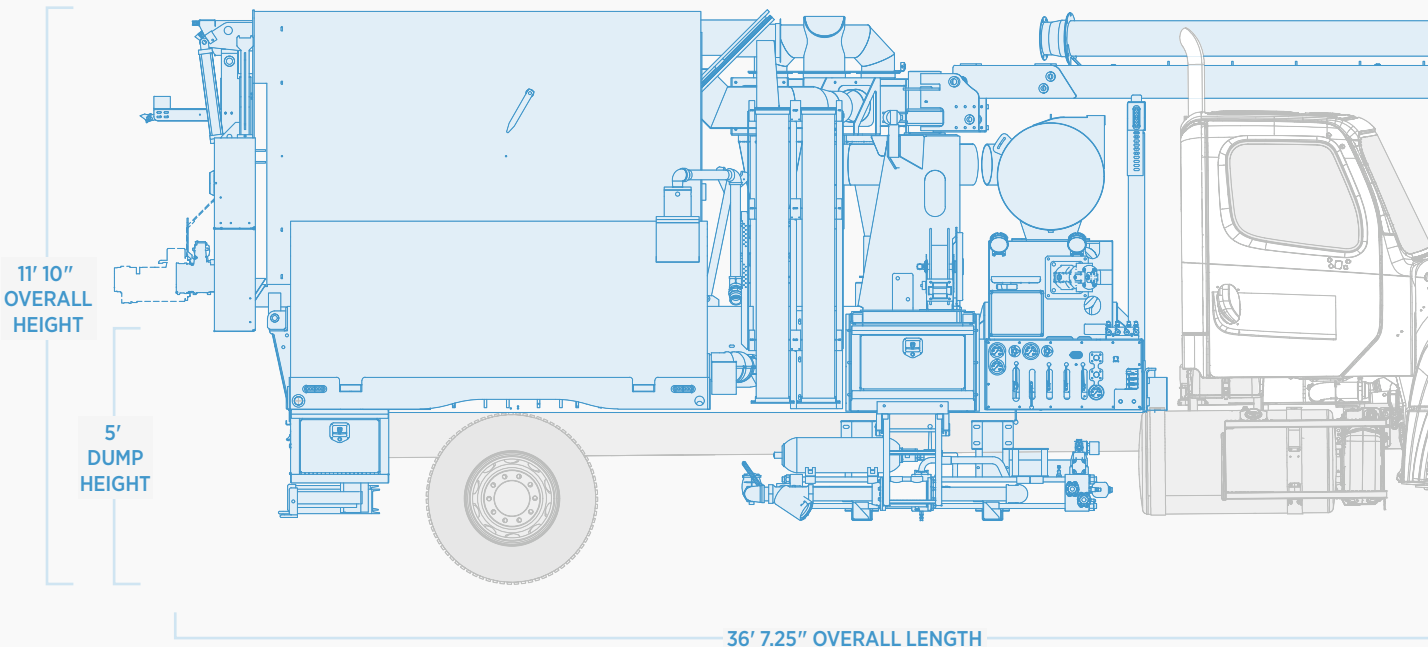

The 900 ECO is available in multiple sizes and configurations.

6 YARD

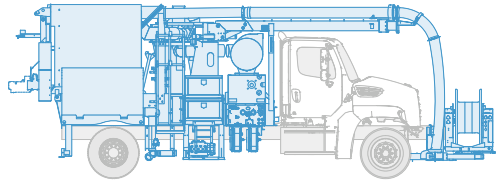

9 YARD

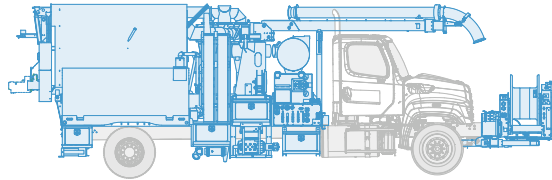

12 YARD

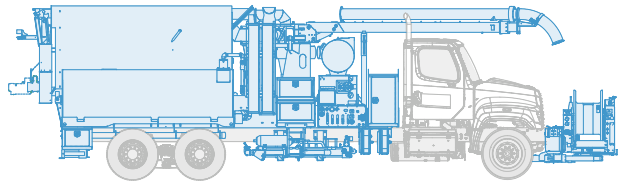

15 YARD

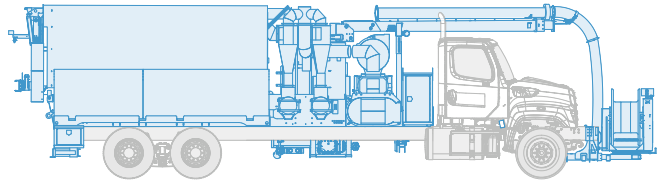

Vacuum Excavators

HX-12 Hydro Excavator

- 5 psi reversible blower
- 3-stage air filtration system with dual 10-micron air filters
- 4" pump off system at 800 gpm with ability to pass up to a 3" solid
- 100% enclosed water and hydraulic system
- Standard Vac-on-the-Go
- 12-volt architecture with no computers or CAN Bus system





Water Tanks

3/4" thickness Duraprolene water tanks

Square design allows for increased water storage

Rated 180 to -40 degrees for windchill

Debris tank options from 3-15 yd³



HX-12



4



5

Hydra-Flex Nozzles



Specialty Sewer Machines



Genesis Water Recycling Sewer Cleaner

400 ECO

- Non CDL
- 4 yd³
- 600 gal water
- 28" PD blower
- Stainless steel construction



AX-4000 Air Excavator



Catch Basin Cleaner



Tempest Industrial Vacuum Loader



Bucket Machine



Sewer Cleaning Nozzles



CLEANING NOZZLES



RAMBO



TORPEDO



TRACTION



ALUMINUM

NOZZLES



O.M.G.



AQUA POWER 700



EQUALIZER



HYDRO EXCAVATION

CAMERAS

KLEEN SIGHT
CAMERA SYSTEM



KLEEN SIGHT
16"



KLEEN SIGHT
NOZZLE BACK



CUTTERS

CHAIN
CUTTER
FAMILY



Micro Chain
2"-6"



Mini Chain
4"-10"



Super Cutter Plus (SCP) 150
6"-16" up to 24"



Super Cutter Plus (SCP) 200
8"-16" up to 48"



Supernova (SN) 4000
6"-16" up to 48"

FLOOR CLEANERS



BOTTOM CLEANERS



TWIN TEN JET FLOOR CLEANERS

Vanguard System



Wastewater and raw sewage contain an abundance of dangerous bacteria, viruses, and parasites. The Vanguard Pathogen Defense System was developed to remove 98% of bacteria and viruses to help keep wastewater workers healthy.

Easy to Use: Click of a button to turn on or off

Adjustable: Spraying system with a 50' reach and provides water volume for SSO clean up

Economical: Few dollars per day to operate

Easy to Install: Installation on ANY make or model of combination, jet or CCTV truck

Built to Last: Lightweight and "NEMA 4" rated control box



The patent pending Vanguard Spray Collar fits easily around most CCTV truck tubing.

- 1 Reelcraft reel and hose
- 2 Spray gun
- 3 12 VDC power cord and electric
- 4 DOT approved nylon tubing
- 5 Main control box
- 6 5 gal antibacterial tank
- 7 Ball valve and brass fittings
- 8 Quad-spray manhole roller
Not shown
- 9 Spray gun nozzles
Not shown



Available Systems

JT System

- Main control box
- Quad-spray manhole roller
- Reelcraft reel: 50' of 1/2" hose
- 5 gal antibacterial storage tank
- Complete installation kit

CCTV System

- Main control box
- Reelcraft reel: 35' of 3/8" hose
- 5 gal cleaning concentrate tank
- Complete installation kit
- Custom-fit water tank (optional)



The spray system also provides the water volume, cleaning, and killing power required for effective SSO clean up.



The Vanguard Spray Collar can mount easily onto most CCTV vehicles.



The system is ideal for cleaning work sites where children may be present.

Manhole & Safety Equipment



DEVIT SYSTEM



LIFEGUARD SYSTEM



FALL ARREST POST SYSTEMS



SAFETY ACCESSORIES



GAS MONITOR



Sonetics®



Sonetics®

Portable, battery-operated and reliable wireless communication solutions for teams of 2 to 20

- Listen-through technology
- Advanced hearing protection
- Rugged and durable
- Custom colors

DECT 7
Wireless



Rental Equipment

Benefits of Renting with BEC

- Daily, weekly, monthly and long-term rental options
- Large selection of makes and models from leading manufacturers
- Equipment is serviced routinely and used machines are well-maintained
- Rental equipment is readily available and delivered promptly
- Unmatched customer service, product knowledge and technical expertise





Camera Services

- Factory certified technicians
- Short turnaround
- Pickup and delivery of parts and equipment
- Loaner and rental equipment available
- Used equipment available
- State-of-the-art repair center
- Servicing Cues, Ratech, Ridgid, Rausch, and Ibak cameras

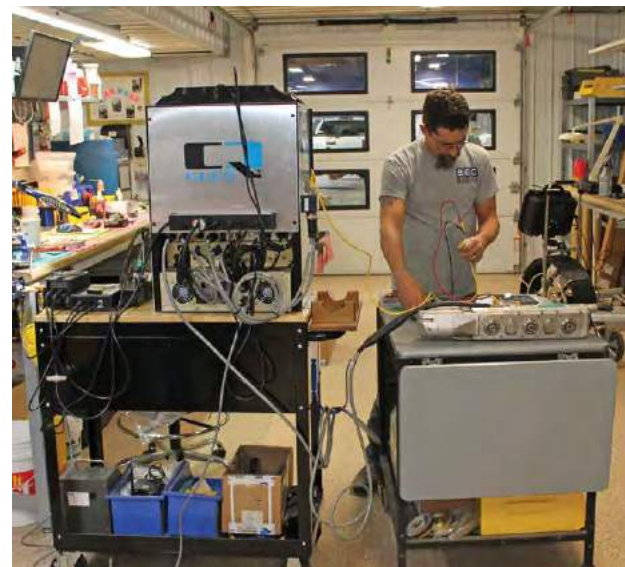

28,000 ft² facility, custom parts, and design custom fabrication





Redi Kit

- 1 Digital high-resolution wide angle web camera
- 2 Diagnostic test box
- 3 Video cables + adapters
Not shown - under foam
- 4 Rugged weather proof storage case
- 5 Footage test box
- 6 Digital multi-meter



Full-Maintenance Service & Repairs

Experience Meets Technical Skill

- Full-Service Maintenance and Repairs on all products, regardless of make or model
- 24 hours a day. 7 days a week.
- Mobile technicians available for field service calls





Preventative Maintenance Program Advantages

Immediate return with operations

Critical inspections completed on regular basis

Extended equipment life

Reduction in unexpected breakdowns

Improved resale value

Improved safety for operators



Preventative Maintenance Programs available for mechanical street sweepers, pure vacuum street sweepers, and leaf collectors.

Reconditioning

Each piece of equipment is inspected and tested before starting the reconditioning process

- Our process includes:
 - Complete disassembly and inspection
 - All wearable items and hoses replaced
 - All subassemblies rebuilt
 - All components are painted and sandblasted prior to assembly
 - New decals if requested



Refurbished WACHS



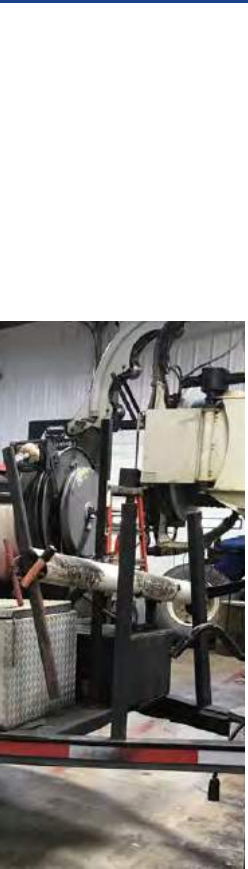

Refurbished Street Sweeper

Each machine is set back to manufacturer specifications and all part replacements are with new OEM parts. After the unit is restored, it goes through an extensive 12 hour minimum of operation and testing to ensure optimal performance of the machine. BEC warranties are available for reconditioned units.

Custom Builds & Fabrication

Fabrication Equipment
Fronius TPS 400I Pulse MIG Welder
Haas Milling Machine
5' x 8' CNC Plasma Table
Acer Hand Lathe with 14" swing and 42" bed and digital readout
Acer End Mill with digital readout
Machine Press
Leister plastic welders
Sheer Brake
12' Metal Brake
CNC Mill

Specializing in metal and plastics fabrication and welding

- Outfit any specialty equipment and make modifications to fit your needs
- Offering the following services:
 - Metal cutting and bending
 - CNC mill work
 - CAD drawing
 - Planning and design
 - Troubleshooting
 - Soldering and brazing



Parts & Accessories



Over
10,000 parts
& accessories
available

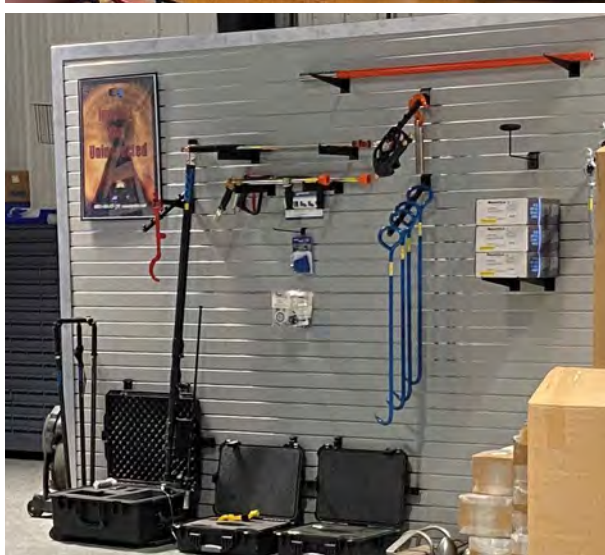

- Extensive inventory of equipment parts and OEM equipment parts
- Available in-house and for delivery
- Authorized dealership for 15 plus manufacturers
- Strategically located service centers for maintenance support
- Pickup, delivery and field calls available

Sample Parts List

Hydro excavation spray guns and nozzles

High pressure washdown guns

Jetting nozzles

Manhole protection rings

Kuriyama hosing, couplings and fittings

KuriKrimp Crimper





BECC
BROWN
EQUIPMENT COMPANY

Serving Indiana, Kentucky, Michigan, and Ohio.



BrownEquipment.net | (800) 747-2312

Serving Indiana, Kentucky, Michigan, and Ohio.